

# **BTX™**

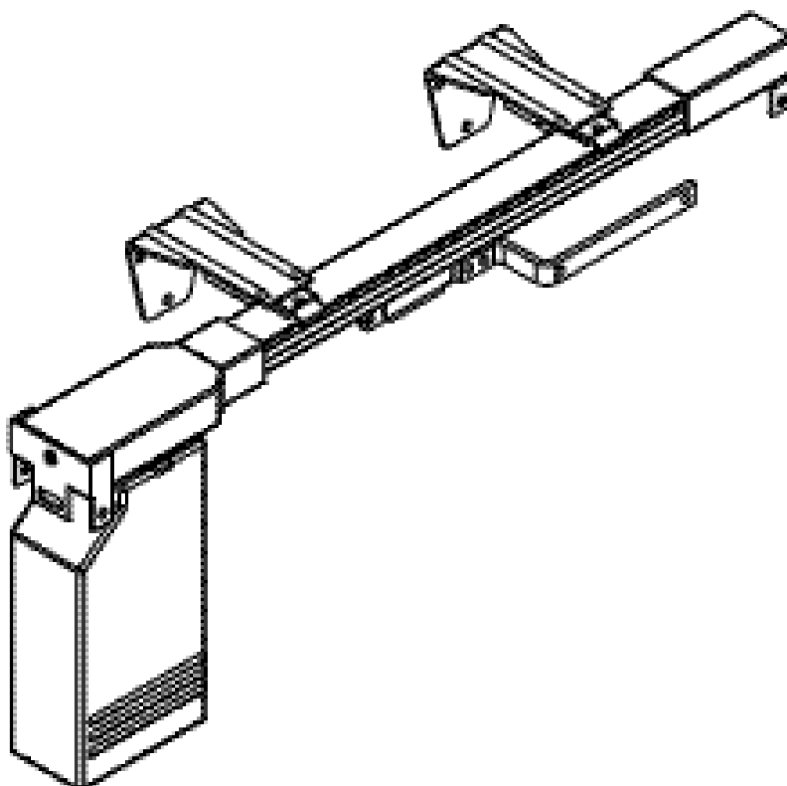

## Installation Instructions for MotorDrape™

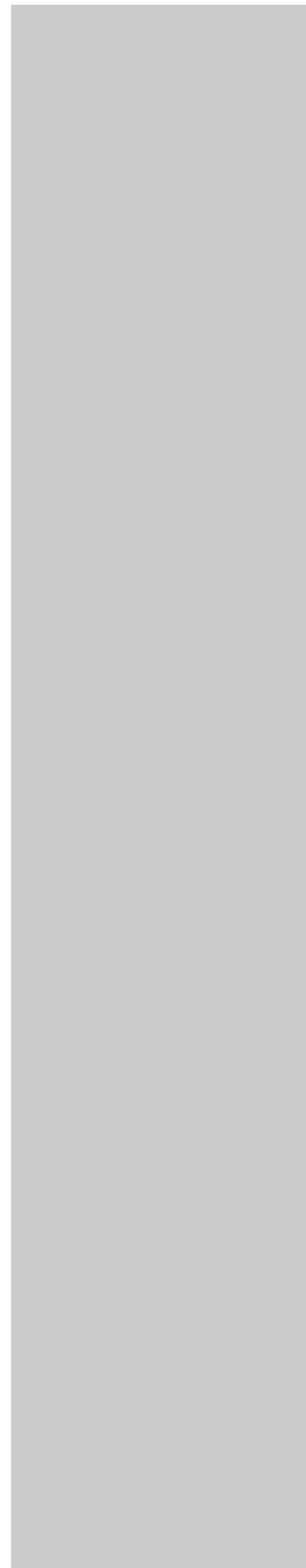

# Table of Contents

Description of MotorDrape™ Systems . . . . . 3

Parts List . . . . . 4

## ASSEMBLY INSTRUCTIONS

Rod Assembly Preparation . . . . . 6

One-way Assembly . . . . . 7

Center Draw Assembly . . . . . 8

Installation Instructions . . . . . 9

## CONTROL INSTRUCTIONS

Control Wiring Connections . . . . . 10

1000 . . . . . 11

2000 . . . . . 12-14

Troubleshooting Tips . . . . . 15

Warranty . . . . . 16

## Tools Required:

Power Screwdriver w/Phillips  
bit

Screws & Anchors  
Needle Nose Pliers Wire  
Cutters

Flathead Screwdriver Small  
Phillips Small Flathead  
Test Cable

Hacksaw (only used for  
cutting down track)

# Description of Systems

## MotorDrape™ 1000 CCM Motor

*Specialized Motor System with Remote and built-in Contact Closure Interface*

The 1000 Switch motor is a unique motor system that allows you to independently operate the motor via the IR handsender, by a low voltage switch or by contact closure which allows you to interface with most audio/video or home automation systems. This system cannot be integrated with the DC 0500 for sheer and overdrape. A complete system includes the headrail system, the motor, an IR receiving eye, an IR handsender, the plug-in power cord and mounting brackets.

The 1000 Series is controlled fully by the handsender. The handsender can operate up to 8 motors independently and is also used to select any of the 10 variable speed settings. Motor addresses are set electronically through the handsender and can be changed at any time.

## MotorDrape™ 2000

*Deluxe Motorized System with Remote and Programmable Control Pad*

The 2000 Series MotorDrape™ DC is similar to the 1000 Series except that it features a programmable control pad. This control pad offers the following functions:

- Manual switch operation (open and close) for 2 systems
- Programmable timer for up to 8 functions per 24 hours (4 open, 4 close)

The control pad also operates as the IR receiving eye for the handsender and is programmable for 10 different speeds. The handsender can operate up to 5 motors independently, or 10 motors when integrated with a DC 0500 for a sheer and overdrape system.

## MotorDrape™ 0500

*Secondary System for Sheer and Overdrape Combinations*

The 0500 Secondary System allows a sheer and a black-out drapery to be integrated. The second MotorDrape™ drapery rod features a "secondary" motor which plugs directly into the primary 2000 motor. The secondary motor receives all power and signals from the primary motor, via a 6-wire connecting signal cord and a connecting power cord.

Using the 0500 Secondary System allows both tracks to operate independently, but requires only one transformer and one handsender for both motors. The 2000 Series utilizes only one wall pad for both motors. In both cases, the wiring and hook-up is simpler and the total cost is less than with two independent systems.

## MotorDrape™ 2000B

*Tandem System for Heavy Draperies*

Certain situations, such as heavy split-draw draperies, may require two MotorDrape™ motors on the same headrail. Such a tandem configuration would allow 120 pounds of drapery to be drawn across a 20 foot, split drawn track. The 2000B configuration requires two 2000 motors, two transformers, one wall pad and one 5-wire connecting signal cable, which snaps in with RJ-12 jacks (telephone type).

# Parts List

## MotorDrape™ DC 1000

CCM includes:

- 1) one drapery rod assembly\*,
- 2) one DC 1000 drapery drive motor,
- 3) one transformer,
- 4) one DC 1000 IR remote controller,
- 5) external IR receiving eye,
- 6) 3" wall/ceiling brackets,
- 7) one wrench.

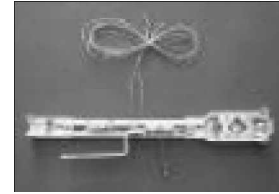

Rod Assembly

## MotorDrape™ DC 2000 includes:

- 1) one drapery rod assembly\*,
- 2) one DC 2000 drapery drive motor,
- 3) one transformer,
- 4) one DC 2000 IR remote controller,
- 5) one control pad,
- 6) 3" wall/ceiling brackets,
- 7) one wrench.



Drive and Non-Drive Motors

## MotorDrape™ DC 1000 or DC 2000

with DC 0500 includes:

- 1) two drapery rod assemblies\*,
- 2) one drapery drive motor,
- 3) one DC 0500 drapery non-drive motor,
- 4) one transformer,
- 5) one IR remote controller,
- 6) one control pad (if using DC 2000), or IR Receiving Eye,
- 7) one signal cord,
- 8) one power cord,
- 9) 6" wall/ceiling brackets,
- 10) one wrench.

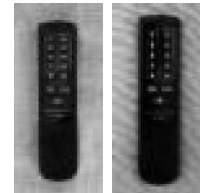

IR Remote Controllers

## MotorDrape™ DC 2000B includes:

- 1) one drapery rod assembly (18 foot),
- 2) two DC 2000 drapery drive motors,
- 3) two transformers,
- 4) one DC 2000 IR remote controller,
- 5) one signal cord,
- 6) 3" wall/ceiling brackets,
- 7) one wrench

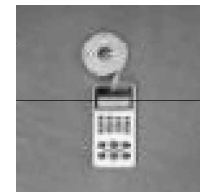

Timer/Wall Control Pad

\*18 foot kits include two 9 foot tracks with a splice.



Transformer

# Getting Started

---

## Working Area

Allow ample working area for the assembly of the MotorDrape™ systems. Depending on the operation the drive and non-drive motor gear covers can be as far as 18' apart during assembly.

## Tools Required

MotorDrape™ systems are easy to assemble. The only tools required are a pair of pliers, a Phillips head screwdriver, a hack saw, and a crimping tool. The wrench to tighten the drapery wire is included with your rod assembly purchase.

## Cutting Track to Size

Determine the overall desired length (end to end) of the rod. Deduct 5" from the overall system length to accommodate the end caps, and mark the rod at this point. Using a hacksaw, cut the headrail at the marks. **Check measurements carefully before cutting track. Do not attach the drive and non-drive gears until you have cut the track.**

\*\*\*Length of aluminum headrail = Overall length of finished headrail less 5"

## Splicing Tracks

When applications require track lengths of 9' or greater, two tracks must be connected using a splice. Tracks should be cut into equal lengths for split draw so that the joint is centered on the rod. For one way operation, cut only one track to adjust length and place splice on far side from motor. Tracks should be inserted equally into the splice, butting them together.

## Motor Placement

Drapery drive motors can be assembled on either the left or right side.

## IR Placement

IR signals require a direct line of sight between the remote control and the IR receiver. Although IR signals may travel through some fabrics, performance varies greatly depending on the application.

If using the 1000 motor and the "no wire" receiving diode, be sure to specify either left or right, depending on which side of the track the motor is mounted on. Use of the wrong diode will significantly affect performance.

# Rod Assembly Preparation

## Rod Assembly

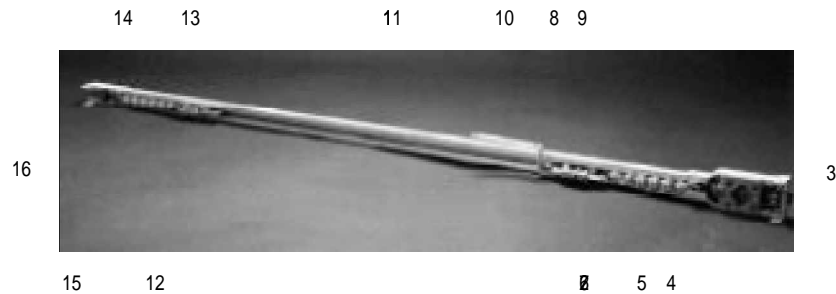

- 1 - Drive Gear
- 2 - Drive Gear Pulley
- 3 - Wire Adjustment Screw
- 4 - Motor Release Button
- 5 - Drive Gear Blocking Screw
- 6 - Carrier
- 7 - Master Carrier "A"
- 8 - Carrier "A" Wire (Station Board)

- 9 - Wire Tightening Screw on Carrier "A"
- 10 - Overlap Arm
- 11 - Track
- 12 - Master Carrier "B"
- 13 - Wire Tightening Screw on Carrier "B"
- 14 - Non-Drive Gear
- 15 - Non-Drive Gear Pulley
- 16 - Non Drive Gear Blocking Screw

## Rod Assembly Preparation

1. Remove twist ties from drapery wire and carefully uncoil.
2. Loosen screws and remove the drive and non-drive gear blocking screws from the temporary track.
3. Carefully detach the drive and non-drive gears and pulley housings from temporary track.
4. Remove master carrier set from temporary track. Discard temporary track.
5. Place the drive and non-drive gears and pulley housings at the fullest distance the drapery wire will allow. Make sure the drapery wire is not tangled. Position the blocking screws near the corresponding pulley housing.
6. With wrench, loosen the wire adjust screw half way. The rod assembly is now ready to be inserted into the aluminum track.

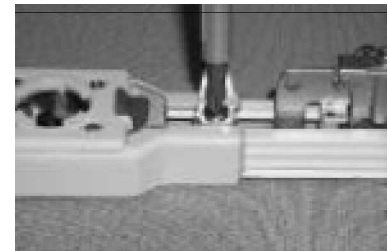

**See page 7 for one way applications and page 8 for center draw applications.**

# One Way Assembly

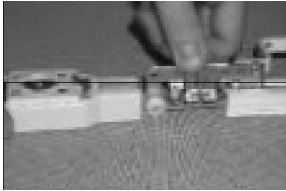

(Fig. 1)

1. Loosen and remove the screw from the master carrier, "B" (closest to the non-drive end). Discard the master carrier.
2. Beginning at the drive end pulley housing end, place the drapery wire into the track about 4", making sure the wire is not twisted or tangled. Gently pulling on the drapery wire, insert the master carrier into the track. The drapery wire should be on the outside of the wheels. Attach the drive gear and pulley housing to the track. Make sure the track is butted up to the stop on the inside of the gear housing. Repeat these procedures on the non-drive end. Install the drive and non-drive blocking screw to the corresponding pulley housings. **(Fig. 1)**

*NOTE: The drapery wire should be fitted into the groove of the pulley in both housings and on the outside of the wheels on the master carrier.*

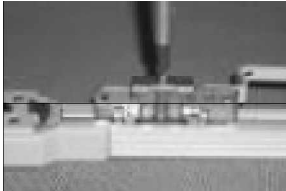

(Fig. 2)

3. Loosen the screw on the top of the master carrier station board "A" (closest to the drive end). **(Fig. 2)** The screw should be loosened only. Do not remove the screw.

4. With pliers, grab the crimped end of the drapery wire. Gently pull all excess wire through. Keeping tension on the wire, re-tighten the screw. Check that the wire is in position. If not, realign **(Fig. 3)** and repeat steps. Move the master carrier by hand to ensure that it moves freely.

*Master carrier movement can be hampered by the following: (a) The wire is twisted, (b) The wire is not routed properly.*

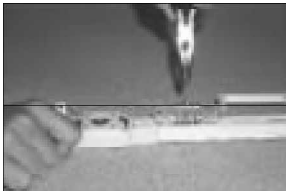

(Fig. 3)

5. With the wrench provided in the rod assembly, turn the drapery wire, adjusting bolt clockwise allowing 1/16" gap between tension plates. **(Fig. 4)** Once again, make sure the master carrier moves smoothly.

*NOTE: Rod lengths greater than 10' may require more tension in order to prevent slipping of the wire on the pulley gears.*



(Fig. 4)

6. Insert appropriate number of carriers at the drive and non-drive in the gear slots. **(Fig. 5)**

7. Install the blocking screw between the track and gear ends. **(Fig. 6)**

*NOTE: If you are going to ship track assembly to your customer, do not ship with carriers in the track. Wire tends to wrap around wheels and impedes operation of track.*



(Fig. 5)

8. Push the sleeve on the drapery wire up to the master carrier. Make sure wire is taut. Crimp the sleeve. Use a flame to lightly scorch one small area of wire. **(Fig. 7,8)** Cut wire where the wire is scorched.

9. The motor is designed to be hidden behind the drapery stack. The rod assembly comes set up for left stacking draperies. If the application calls for right stack, simply reverse the overlap arm on the master carrier.

10. Attach the overlap arm to the master carrier. The overlap arm should project into the interior of the room once the track is installed.

11. The track is ready to be installed onto the ceiling/wall brackets.

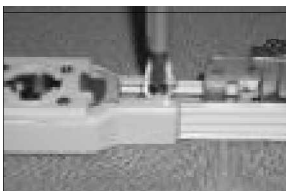

(Fig. 6)

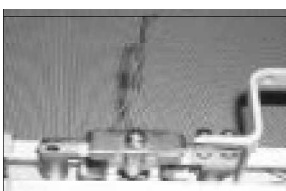
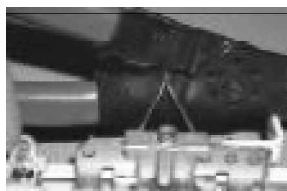

(Fig. 7)

(Fig. 8)

# Center Draw Assembly

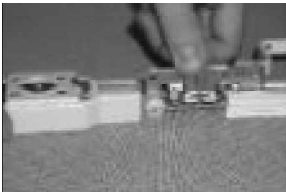

(Fig. 1)

1. Beginning at the drive end pulley housing end, place the drapery wire into the track about 4", making sure the wire is not twisted or tangled. Gently pulling on the drapery wire, insert the master carrier into the track. The drapery wire should be on the outside of the wheels. Attach the drive gear and pulley housing to the track. Make sure the track is butted up to the stop on the inside of the gear housing. Repeat these procedures on the non-drive end. Install the drive and non-drive blocking screw to the corresponding pulley housings. **(Fig. 1)**

*NOTE: The drapery wire should be fitted into the groove of the pulley in both housings and on the outside of the wheels on the master carrier.*

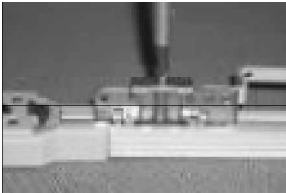

(Fig. 2)

2. Loosen the screw on the top of the master carrier "A" (closest to the drive end). The screw should be loosened only. Do not remove the screw. **(Fig. 2)**

3. With pliers, grab the crimped end of the drapery wire. Gently pull all excess wire through. Keeping tension on the wire, retighten the screw. Check that the wire is in position. If not, realign and repeat steps. Move the master carrier by hand to ensure that it moves freely. **(Fig. 3)**

*Master carrier movement can be hampered by the following: (a) The wire is twisted, (b) The wire is not routed properly.*

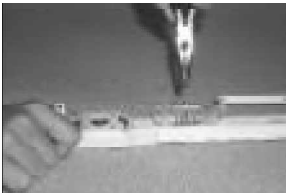

(Fig. 3)

4. Adjust center open position of draperies by loosening the screw on the master carrier station board. Loosen the screw only; do not remove it completely. By loosening this screw, the master carrier will slide on the drapery wire allowing adjustment for center open draperies. There should be some resistance as the master carrier moves along the wire. Retighten the screw. Adjustments to draperies is possible once the draperies are installed. Simply put the drapery in the closed position and repeat the process.

5. With the wrench provided in the rod assembly, turn the drapery wire **(Fig. 4)**, adjusting bolt clockwise allowing 1/16" gap between tension plates. Once again, make sure the master carrier moves smoothly.

*NOTE: Rod lengths greater than 10' may require more tension in order to prevent slipping of the wire on the pulley gears.*

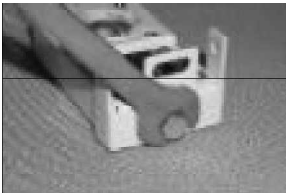

(Fig. 4)

6. Insert appropriate number of carriers at the drive and non-drive in the gear slots. **(Fig. 5)** *NOTE: If you are going to ship track assembly to your customer, do not ship with carriers in the track. Wire tends to wrap around wheels and impedes operation of track.*



(Fig. 5)

7. Install the blocking screw between the track and gear ends. **(Fig. 6,7)**

8. Push the sleeve on the drapery wire up to the master carrier. Make sure wire is taut. Crimp the sleeve. Use a flame to lightly scorch one small area of wire. Cut wire where the wire is scorched. **(Fig. 8,9)**

9. Attach the overlap arm to the master carrier (if not already attached). The overlap arm should project into the interior of the room once the track is installed.

10. The track is ready to be installed onto the ceiling/wall brackets.

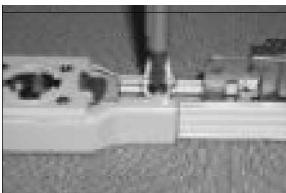

(Fig. 6)

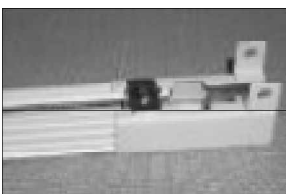

(Fig. 7)

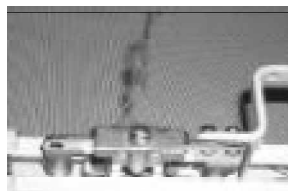

(Fig. 8)

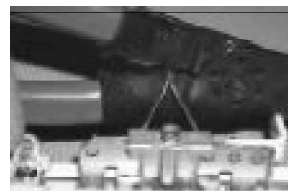

(Fig. 9)



# Installation Instructions

All MotorDrape™ kits are supplied with wall/ceiling brackets. As various building materials are used in construction, BTX does not supply fasteners. Fasteners can be purchased at all hardware stores. The recommended fasteners for most common applications would be a 1-1/2" slotted hex washer square drive head screw in conjunction with a 1-1/2" hollow wall anchor. All brackets should be installed in a straight line, approximately every 24".

It is important in operating the system that the track be mounted straight and level. To ease the process of bracket mounting, place a wall/ceiling bracket on the track every 24", making sure that a bracket is close to each end as this is where the most weight will be placed when the draperies are open.

Position the track in the desired location and mark the bracket mounting holes. Detach the brackets from the track, drill the marked holes to size for the chosen fasteners and attach brackets.

Starting at the center of the track, snap track into brackets. A "click" will be heard when track snaps in place.

## Bracket Installation Distance



Note: 23" - 25" is the maximum recommended distance between brackets. For greater weights or more demanding installations, additional brackets should be used.

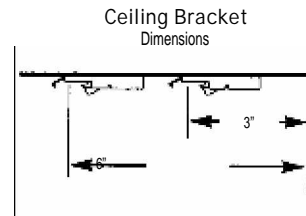
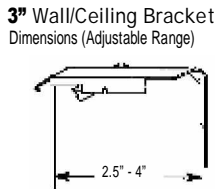
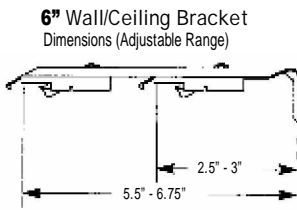

### CAUTION

When mounting tracks to wall or ceiling, allow extra space for the floor and track clearance. Draperies dragging on the floor or encountering resistance will affect the performance of the motor system. Typical allowance would be 1-1/2" to 2" greater than drapery length.

## Attaching the Motor

With track mounted to either the wall or ceiling, attach the motor to the track.

1. Holding the motor at a 45° angle to the track, press upward into the Drive Gear Housing (red button pressed into housing). Twist motor back 45°. The red button will automatically lock into place. Once the red button has locked into place, gently twist the motor to ensure it is securely attached.

2. Connect the transformer to port 1 and the infrared receiving eye into port 2. Position the receiving eye so as to have the black part facing the room. (See page 10.)

*NOTE: All MotorDrape™ kits are set up for stack left, motor left, diode left. If the application requires stack right, motor right, diode right, please specify when purchasing kit.*

3. Hang draperies. Remember to adjust the drapery pins so that the draperies hang just below the bottom of the track.

4. Plug transformer into standard 120V receptacle.

*NOTE: The infrared receiving eye is designed to be hidden from view and still receive the signal through most draperies. However, some applications may call for a cornice board, valance or similar top treatment. BTX offers optional infrared diodes in these situations.*

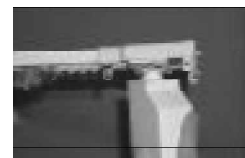
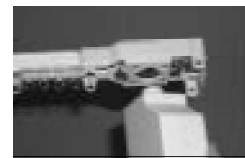

# Control Wiring Connections

MotorDrape™ Single System 1000 or 2000

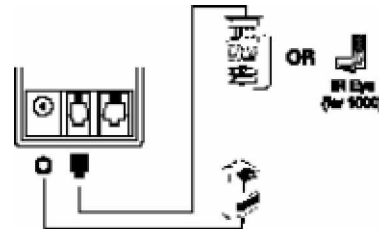

MotorDrape™ 2000A - Paired Systems - Sheer and Overdrape (A)

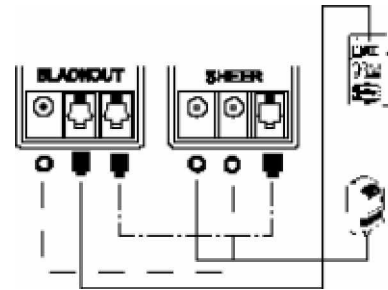

MotorDrape™ 2000B - Tandem System - Simultaneous Operation (B)

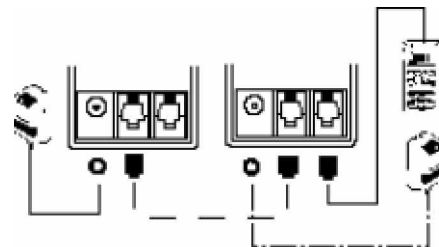

MotorDrape™ 2000C - Multiple Systems - Simultaneous Operation (C)

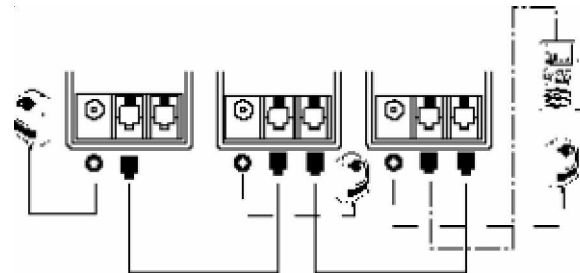
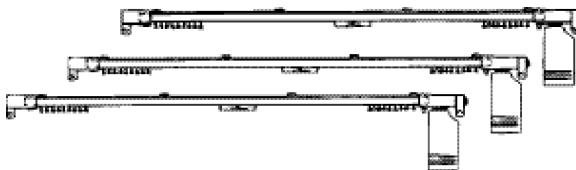

**WARNING**

MotorDrape™ transformer is dedicated transformer. Customer should not exchange, extend or use other brands of transformers with the Drapery Opener System.

# Control Instructions - 1000

## Using the Handheld Remote Control

The 1000 has an eight channel remote control, which gives you the ability to control up to eight different systems individually.

To open the 1000, press the channel number (1,2,3...) of the drapery you wish to open. Then press the open button. (Arrows pointing out)

To close the 1000, press the channel number (1,2,3...) of the drapery you wish to close. Then press the close button. (Arrows pointing in)

To stop the 1000 press the stop button. (Square)

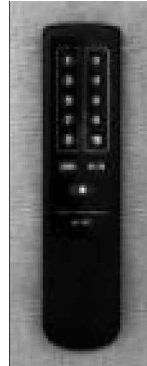

## Setting the channel number on the 1000

To set the channel on your 1000 please make sure motor is plugged in, remote control has batteries and diode is plugged into motor, then follow these steps:

### Steps

- 1 - Using the 1000 remote control, press the desired channel number of 1 - 8. Once the light on the remote comes on release the button.
- 2 - Using a paper clip, or pen press and hold the recessed button on the side of the 1000 motor, and at the same time press either the open or the close button on the remote. Release after several seconds.
- 3 - Press the open or close buttons to test the motor. The motor is now programmed to the selected channel.

## Setting the variable drapery speed of the 1000

The MotorDrape™ has ten different speeds for you to choose from (0-9, with zero being the slowest and nine being the fastest). To change the speed of your 1000, follow these steps using the hand held remote control -- Factory preset at speed 9.

### Steps to Decrease Speed

- 1 - Press the "10" button once for each decreasing increment.

*Example: The level is at 7, press "10" twice and the speed is now at 5.*

- 2 - Using the remote control, open or close the drapery to see if the speed meets your requirements. Repeat if necessary.

### Steps to Increase Speed

- 1 - Press the "9" button once for each increasing increment.

*Example: The level is at 6, press "9" twice and the speed is now at 8.*

- 2 - Using the remote control, open or close the drapery to see if the speed meets your requirements. Repeat if necessary.

## Switch or Contact Closure Hookup for 1000 Switch Motor

Using a 6-conductor modular cable in conjunction with a RJ-12 plug, cut the Blue, Green and Red wires and crimp the plug. The Yellow and White are directional wires and the Black is your common.

NOTE: When cutting the wires, please cut flush with outer jacket.

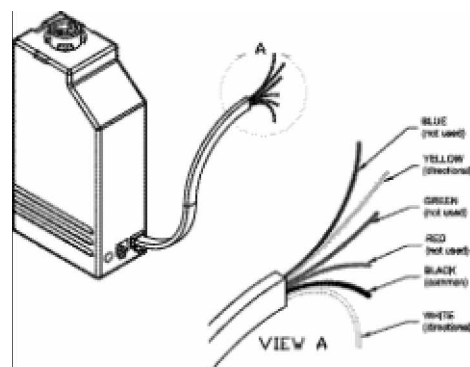

# Control Instructions - 2000

Using the manual switches on the control pad for the 2000  
Built onto the control pad are manual switches for both the front drapery (FB-1) and the back drapery (FB-2).  
Follow these steps to operate the switches.

1. To open, press the "open" button.  
(Arrows pointing out)
2. To close, press the "close" button.  
(Arrows pointing in)
3. To stop, press the "stop" button.  
(Square)

**Note: On a double application (Sheer & Blackout), you cannot have both systems operating via switch or other functions at the same time.**



Using the Handheld Remote Control  
The 2000 has the ability to control up to ten systems individually.

To open the 2000, press the channel number (1,2,3...) of the drapery you wish to open. Then press the open button.  
(Arrows pointing out)

To close the 2000, press the channel number (1,2,3...) of the drapery you wish to close. Then press the close button.  
(Arrows pointing in)

To stop the 2000 press the stop button. (Square)

Setting the handsender channel number on the 2000  
To set the handsender channel on your 2000, please use the control pad, following these steps:

#### Steps

- 1 - Press button "9" (SET)
- 2 - Press button "1" (P/NO)
- 3 - Press the desired channel number (1,3,5,7, or 9 only when using a single 2000 system)
- 4 - Press "EN" button

When using a double system (Sheer & Blackout), set the front drapery (FB-1) to an "odd" channel number. Example: 1,3,5,7,9. The back drapery (FB-2) will automatically become the next "even" channel number. Example: If you select channel 3 for the front, the back will become channel 4.

#### WARNING



- Control pad should not be installed outdoors or in a high temperature area. Temperature cannot exceed 50°C (122°F). Avoid direct sunlight.
- Control pad should not be installed in low temperature areas. LCD response time may be slowed and the clock may become inoperative. Low temperature symptoms are not permanent. Normal function will return after the timer warms up.
- Do not drop or impact the control pad or motor. Do not try to disassemble the unit in any way.
- Do not install at locations close to other electrical appliances.
- Do not clean the control system with alcohol, benzene or thinner products. Use a nonabrasive soap and damp sponge.

# Control Instructions - 2000

## Setting the speed for the 2000

To set the speed (increase or decrease) of your 2000 you will use the control pad using the following steps:

### Steps

- 1 - Press button "9" (SET)
- 2 - Press button "2" (SPD)
- 3 - Press the desired setting  
*Example: (0,1,2 ...,9) - "0" is the slowest, "9" is the fastest*
- 4 - Press "EN" button

Unlike the 1000 where you use the remote, because you are using the control pad, the number you select will be visible on the display.

## The MotorDrape™ 2000 control/timer pad

The MotorDrape™ 2000 is controlled via a technically advanced processor, yet the control pad is extremely easy to program and use. The control pad features manual open/close buttons, a clock, a fully programmable timer and an integrated infrared receiving eye.

- (A) The display panel will show the various functions that you either program or have selected to use.
- (B) The numerical keypad section allows you to set the programming for the timer as well as the settings for any of the operating programs. Example: drapery speed, channel number, etc.
- (C) The manual open/close buttons allow you to open, close or stop the drapery in any position. FB-1 switches the front drapery, FB-2 switches the back drapery.

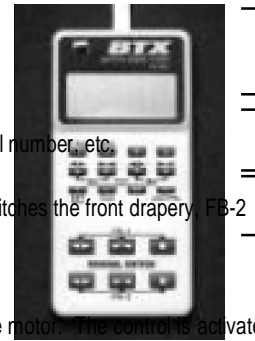

The control pad comes standard with a 4 foot modular connecting wire that simply plugs into the side of the motor. The controls are activated as soon as the motor's power supply is plugged into a wall outlet. "12:00" will then begin to flash on the display panel.

## Setting the digital clock on the 2000 control pad

The control pad for the 2000 includes a highly accurate digital clock. To set the control pad for the actual time of day, follow these easy steps.

Step	Action
1 - Press button "0" (CLK)	The flashing time will stop
2 - Program desired time <i>Example: 12:45 - Press buttons "1", "2", "4", then "5"</i>	The display will show the programmed time of 12:45
3 - Press "AU" button to select either AM or PM	AM or PM will appear on the left side of the display
4 - Press "EN" button	The colon on the display starts to flash; the clock is now working

# Control Instructions - 2000

## Programming the timer

Your MotorDrape™ can be set to open and close automatically at the time of your choosing. This can be done up to eight times (4 open & 4 close) per day, per drapery (front or back).

Follow these easy steps to set your programmable timer for the times you want the drapes to open or close automatically.

### Open Position Setting

Step	Action
1 - Press button "5" for front drapery (FB-1) or "7" for back drapery (FB-2) to activate the control in the open mode	The display shows the colon and a dash
2 - Press button "1" to put control in the time set mode	The display will be blank or show previously set time command
3 - Program desired time <i>Example: 11:45 - Press "1", "4" then "5"</i>	The display shows 11:45
4 - Press "AU" button to select either AM or PM	The display shows either AM or PM
5 - Press "EN" button to save this time setting.	The display reverts back to the clock display

*NOTE: To set additional open settings repeat steps 1 through 5, pressing '2', '3', or '4' for 2nd, 3rd and 4th time settings in **step two**.*

### Close Position Setting

Step	Action
1 - Press button "6" for front drapery (FB-1) or "8" for back drapery (FB-2) to activate the control in the open mode	The display shows the colon and a dash
2 - Press button "1" (P/NO) to put control in the time set mode	The display will be blank or show previously set time command
3 - Program desired time <i>Example: 1:25 - Press "1", "2" then "5"</i>	The display shows 1:25
4 - Press "AU" button to select either AM or PM	The display shows either AM or PM
5 - Press "EN" button to save this time setting.	The display reverts back to the clock display

*NOTE: To set additional open settings repeat steps 1 through 5, pressing '2', '3', or '4' for 2nd, 3rd and 4th time settings in **step two**.*



You must activate the timer!!! Press "AU" button to turn on the "AUTO" function. "Auto" will appear in the lower left corner of the digital display.

# Troubleshooting Tips

Problem	Cause	Solution
Remote control unit does not operate.	<p>Power supply is not plugged in properly.</p> <p>Battery in remote control is dead.</p> <p>Receiving diode is obstructed.</p> <p>For 1000, using Right eye in Left application or Left eye in Right application.</p>	<p>Plug power supply in correctly.</p> <p>Replace battery in remote control.</p> <p>Remove the interfering object.</p> <p>Either get a correct eye for correct motor location or get an extended eye that works on either side.</p>
Motor does not stop automatically at either open or close.	Not enough tension on the cable.	Increase tension of the cable by turning wire adjusting screw.
Can operate one drive motor, but not the second or third drive motor.	Signal cord is not properly connected.	Reconnect cord according to instructions in this manual.
Draperies stop automatically before it is fully opened or closed.	Interference with movement of the drapery.	Remove object which restricts the drapery movement.
Cannot open or close by hand.	Assembly of the drapery track was incorrect. Cable is probably wrapped around wheels of carriers.	Reassemble track according to instructions in this manual.

# Warranty & Return Policy

---

BTX extends a Three-Year Limited Warranty for MotorDrape™ DC systems and controls. These products are thoroughly inspected and tested before leaving the factory. They are warranted to be free of defects in materials and workmanship for a period of three years from the date of shipment from the Dallas factory of BTX. Should any trouble develop during the three-year period, contact the factory for a RGA (Return Goods Authorization) number and return the product, freight prepaid. If inspection shows the trouble was caused by defective materials or workmanship, BTX will repair (or at its option, replace) the nonconforming part without charge.

This warranty does not apply where:

1. Repairs have been made or attempted by persons other than a factory authorized person.
2. Repairs are required because of normal wear and tear.
3. The product has been abused, misused, improperly maintained or malfunctions due to errors in customer assembly or the installation.
4. Alterations have been made to the unit.

IN NO EVENT SHALL BTX OR HOUSTON AUTOMATED SHADE & DRAPERY (AUTOMATEDSHADE.COM) BE LIABLE FOR ANY INDIRECT, INCIDENTAL, CONSEQUENTIAL OR OTHER DAMAGES IN CONNECTION WITH THIS PRODUCT. THIS DISCLAIMER APPLIES BOTH DURING AND AFTER THE PERIOD OF THIS WARRANTY.

THE FOREGOING WARRANTY IS EXCLUSIVE AND IN LIEU OF ALL OTHER WARRANTIES, WHETHER WRITTEN, ORAL OR IMPLIED. ALL OTHER WARRANTIES, INCLUDING ANY WARRANTY OF MERCHANTABILITY OR FITNESS FOR A PARTICULAR PURPOSE, ARE HEREBY DISCLAIMED. Correction of nonconformities as provided above shall be purchaser's exclusive remedy and shall constitute fulfillment of any and all responsibilities of BTX and Houston Automated Shade (AutomatedShade.com), whether in warranty, contract, negligence, tort or otherwise with respect to the equipment or part delivered hereunder. In no event shall BTX, Houston Automated Shade & Drapery (AutomatedShade.com) be responsible for providing working access to the defect, including disassembly or reassembly of equipment or parts.

12/9  
9

## Disclaimer

BTX reserves the right to make changes or improvements on any terms without incurring any obligation and without being required to make any corresponding changes or improvements on items previously sold, and to discontinue models or accessories at any time without notice. BTX reserves the right to make product specification changes without prior notice.